

Datasheet - RDMSW

Command and signalling devices / Push buttons and pilot lights - "R" Program / RD - Push button



- Push button with membrane
- Symbols still clearly visible under transparent membrane



(Minor differences between the printed image and the original product may exist!)

Ordering details

Product type description	RDMSW
Article number	101188272
EAN Code	
eCl@ss	27-37-12-13

Approval

Approval



Global Properties

Permanent light	RD - Push button with membrane
Standards	IEC/EN 60947-1, EN 60947-5-1
Compliance with the Directives (Y/N)	No
Suitable for safety functions (Y/N)	No
Mounting	mounting flange RLM
Materials	
- Material of the operators	Aluminium
- Material of the front ring	Aluminium
Design	Embeddable button - Front plate mounting
Form	Round
Color	

- Colour of the operating element	■ Black
- Colour of the front ring	■ Silver
Weight	40
Can be illuminated (Y/N)	No
With membrane (Y/N)	Yes

Mechanical data

Mechanical life	10.000.000 operations
Switching frequency	1200
Actuating force	2
Actuating stroke	4
restistance to shock	< 50
Latching (Y/N)	No
Unlocking type	without
Probing possible (Y/N)	Yes
mounting flange available (Y/N)	Yes
Front plate thickness	
- min. front plate thickness	1
- max. front plate thickness	6
Tightening torque for fixing screws	2

Ambient conditions

Ambient temperature	
- Min. environmental temperature	-25
- Max. environmental temperature	+75
Storage and transport temperature	
- Min. Storage and transport temperature	-
- Max. Storage and transport temperature	-
Fully insulated (Y/N)	Yes
Sealing type	membrane, lip seal, Form seals
Protection class	IP65

LED switching conditions display

With integrated LED (Y/N)	No
---------------------------	----

Dimensions

Dimensions	
- Height	12
- Diameter total	39.5
Height of touch surface	1.5
Diameter of touch surface	28
Hole, diameter	22.3 + 0,4
Spacing	40 x 60

notice

The membrane protects the button against grinding dust or other pasty, viscous substances.

Included in delivery

Mounting flange RLM (1188815) is included in delivery

Documents

Operating instructions and Declaration of conformity (it) 1 MB, 13.06.2019

Code: mrl_programme-e-n-r_it

Operating instructions and Declaration of conformity (en) 1 MB, 06.11.2018

Code: mrl_programme-e-n-r_en

Operating instructions and Declaration of conformity (pl) 1 MB, 13.06.2019

Code: mrl_programme-e-n-r_pl

Operating instructions and Declaration of conformity (jp) 2 MB, 28.06.2017

Code: mrl_programme-e-n-r_jp

Operating instructions and Declaration of conformity (pt) 1 MB, 21.12.2018

Code: mrl_programme-e-n-r_pt

Operating instructions and Declaration of conformity (de) 1 MB, 06.11.2018

Code: mrl_programme-e-n-r_de

Operating instructions and Declaration of conformity (es) 1 MB, 05.12.2018

Code: mrl_programme-e-n-r_es

Operating instructions and Declaration of conformity (nl) 1 MB, 05.12.2018

Code: mrl_programme-e-n-r_nl

Operating instructions and Declaration of conformity (fr) 1 MB, 05.12.2018

Code: mrl_programme-e-n-r_fr

Operating instructions and Declaration of conformity (cn) 2 MB, 21.06.2017

Code: mrl_programme-e-n-r_cn

Images

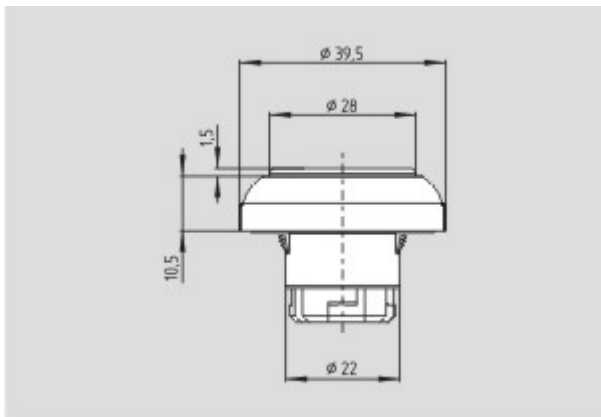

Dimensional drawing (basic component)

System components

contact element



contact element RF

- Screw connection
- 1-2 (Contact labelling)

spare part



mounting flange (R)

K.A. Schmersal GmbH & Co. KG, Möddinghofe 30, D-42279 Wuppertal

The data and values have been checked thoroughly. Technical modifications and errors excepted.

Generiert am 14.11.2019 - 08:21:34h Kasbase 3.3.0.F.64I